

# DOPAK® Process Sampler Type S32-G

## system purge configuration

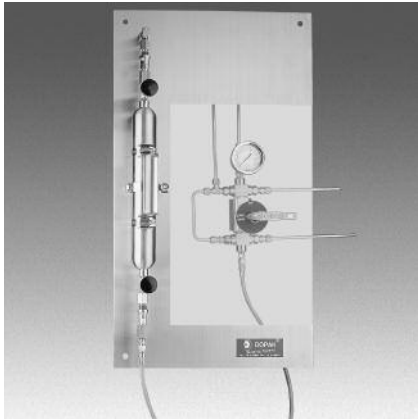

The ability to purge the sample point ensures optimal retrieval of a representative, contamination free sample. The S32-G type samplers provide a system purge in addition to sampling in a sample cylinder and the ability to depressurise the quick connect couplings before disconnecting the sample cylinder. The unique design offers a one handle operation by multiple valves. These features provide sample accuracy and safety.

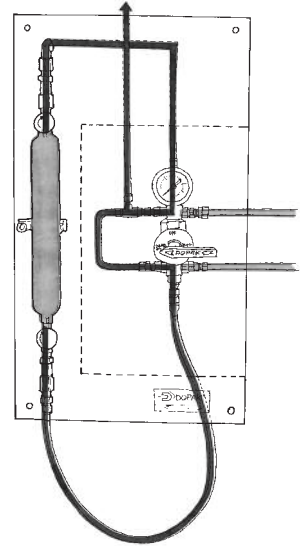

### 1 OPERATION/FUNCTION

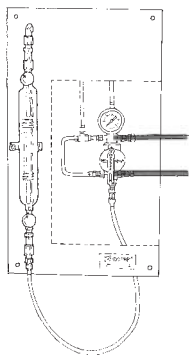

**0 - off**  
Install the sample cylinder and connect the flexible hose to the bottom side of the sample cylinder. Open the needle valves of the sample cylinder.

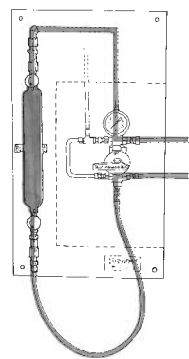

**1 - system purge**  
Turn the handle to the "process" position, allowing the sample cylinder to be filled. To ensure a representative sample, this position can be held for any required time.

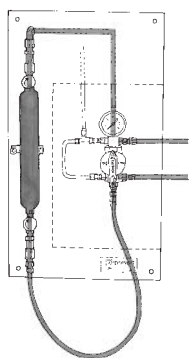

**2 - off**  
Turn the handle in the "off" position. Close the two needle valves of the sampling cylinder.

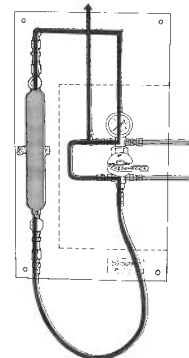

**3 - depressurise/vent**  
Turn the handle to the "depressurise" position. The internal connection between the sample cylinder and the vent connection has now been made. The quick connects are being depressurised to the vent connection.

### 2 TYPICAL P & ID

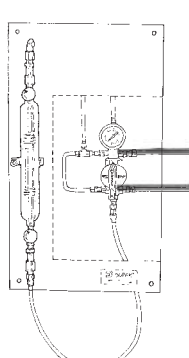
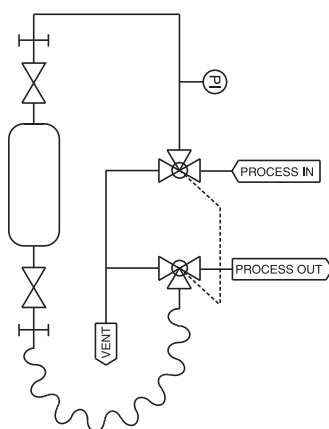

**4 - off**  
Turn the handle to the "off" position. Disconnect the flexible hose. Remove the sample cylinder and connect the flexible hose to the top quick connect.



### 3 FEATURES/ADVANTAGES/PROPERTIES

- Sampling in cylinder at process pressure
- Representative sampling
- Zero dead volume
- Closed sampling
- One handle operation of mutiple valves
- Fixed volume sampling
- Purging of sampler
- No direct connection between vent line and process lines
- Depressurising of quick connect couplings

### 4 BASIC SPECIFICATIONS

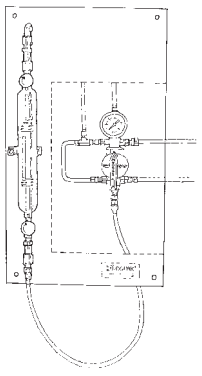
<b>Material</b>	SS316, SS316L.	
<b>Cylinder Type</b>	500cc cylinder.	
<b>Valve</b>	Three-way ball valve type W83. PTFE seats, Viton A O-rings. Pressure range 103 bar @ 20°C (1500 psig @ 70°F). Temperature range -17/+232°C (0/+450°F).	
<b>Operation</b>	Manual.	
<b>Connections</b>	1/4" FNPT. Pressure gauge included.	

**Please note:** the above is a basic specification only. DOPAK® Samplers can be offered with a wide variety of options as mentioned below.

### 5 OPTIONS

- Spring return handle
- Lockable handle
- Pipe stand
- Block valve
- Flow meter
- Enclosure
- Sample cooler
- Exotic materials
- Larger/smaller sample size

For more information please refer to our sheets:  
**Options for DOPAK® process sampler type S32-G.**  
**Components for DOPAK® process samplers.**

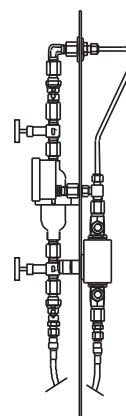
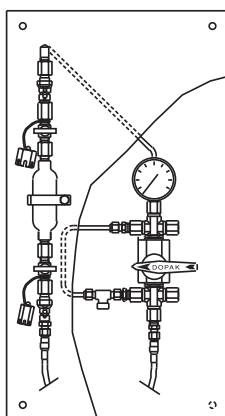
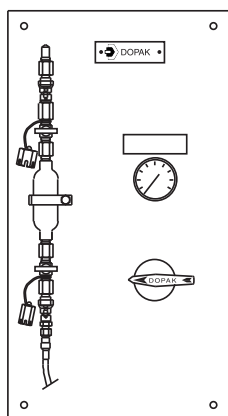

**Dopak Inc.**  
 Houston, Texas 77041, USA  
 Phone 713-460-8311  
 Fax 713-460-8578  
 E-mail info@dopak.com

**Dovianus BV**  
 Bergschenhoek, The Netherlands  
 Phone +31 10 524 20 00  
 Fax +31 10 456 67 74  
 E-mail info@dopak.nl

**Your local representative:**