

DOPAK® Process Sampler Type S32-LG

process to flare with outage tube configuration

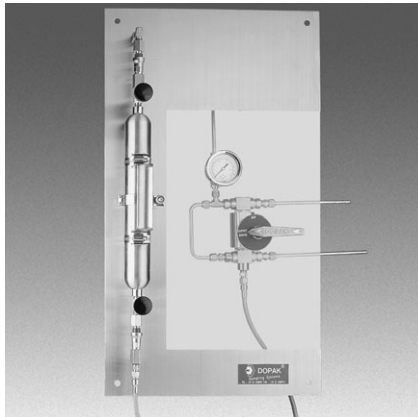

The ability to purge the sample point ensures optimal retrieval of a representative, contamination free sample. The S32-LG type samplers provide system purge to a flare connection in addition to sampling in a sample cylinder with predefined filling rate. The predefined filling rate is achieved by using an outage tube in the sample cylinder. The unique design offers a one-handle operation by multiple valves. These features provide sample accuracy and safety.

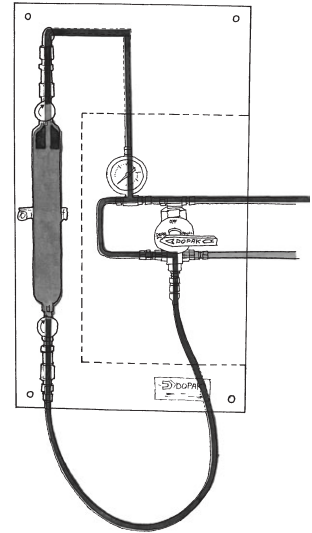

1 OPERATION/FUNCTION

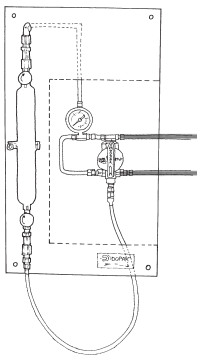

0 - off
Install the sample cylinder and connect the flexible hose to the bottom side of the sample cylinder. Open the needle valves on the sample cylinder.

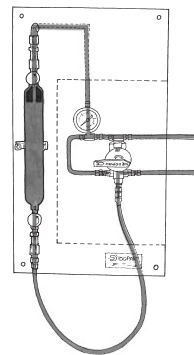

1 - system purge
Turn the handle to the "process" position, allowing the sample cylinder to be filled. To ensure a representative sample, this position can be held for any required time.

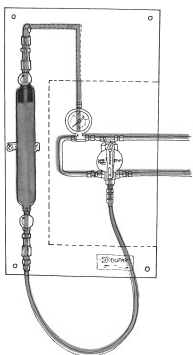

2 - off
Turn the handle to the "off" position. Close the two needle valves on the sample cylinder.

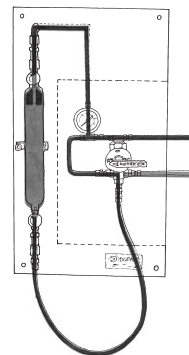

3 - depressurise/vent
Turn handle to the "depressurise" position. The internal connection between the sample cylinder and the flare connection has now been made. The quick connects are being depressurised and vented to the flare connection.

2 TYPICAL P & ID

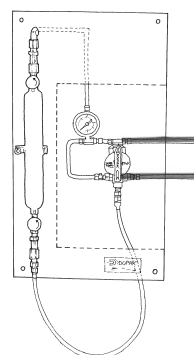
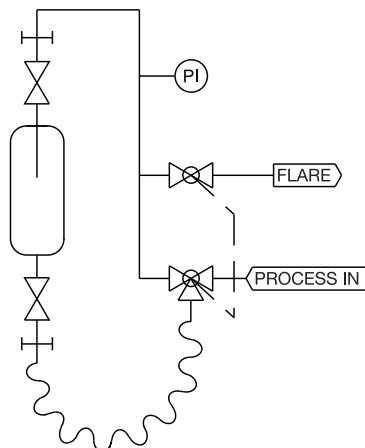

4 - off
Turn the handle to the "off" position. Disconnect the flexible hose. Remove the sample cylinder and connect the flexible hose to the top quick connect.



3 FEATURES/ADVANTAGES/PROPERTIES

- Sampling in cylinder with predefined filling rate
- Representative sampling
- Zero dead volume
- Closed sampling
- One-handle operation of multiple valves
- Fixed volume sampling
- Purging of sampler
- Depressurising of quick connect couplings

4 BASIC SPECIFICATIONS

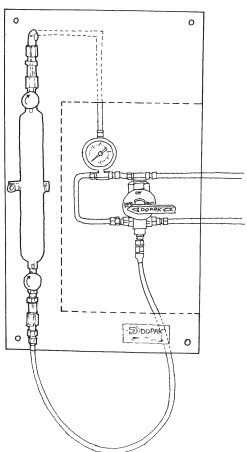
Material	SS316, SS316L.	
Cylinder Type	500cc cylinder.	
Outage Tube	Suited for 85% filling of sample cylinder.	
Valve	Three-way ball valve type W83. PTFE seats, Viton A O-rings. Pressure range 103 bar @ 20°C (1500 psig @ 70°F). Temperature range -17/+232°C (0/+450°F).	
Operation	Manual.	
Connections	1/4" FNPT.	

Please note: the above is a basic specification only. DOPAK® Samplers can be offered with a wide variety of options as mentioned below.

5 OPTIONS

- Spring return handle
- Lockable handle
- Pipe stand
- Block valve
- Flow meter
- Enclosure
- Sample cooler
- Exotic materials
- Larger/smaller sample size

For more information please refer to our sheets:
Options for DOPAK® process sampler type S32-LG.
Components for DOPAK® process samplers.

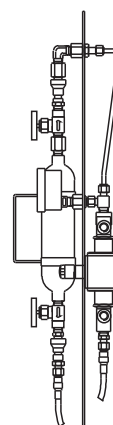
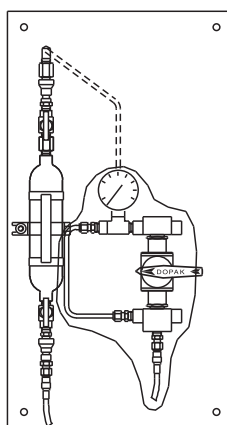
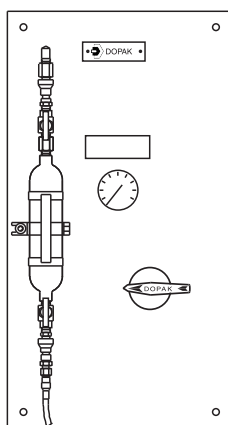

Dopak Inc.
Houston, Texas 77041, USA
Phone 713-460-8311
Fax 713-460-8578
E-mail info@dopak.com

Dovianus BV
Bergschenhoek, The Netherlands
Phone +31 10 524 20 00
Fax +31 10 456 67 74
E-mail info@dopak.nl

Your local representative: